

SHIMANO STEPS

SHIMANO Total Electric Power System

User's manual

E8000 Series

Original instructions

CONTENTS

IMPORTANT NOTICE	2
Important safety information	2
To ensure safety	2
NOTICE	3
Booklet Structure	6
Features of SHIMANO STEPS	7
Riding the bicycle	7
Assist mode	8
Names of parts	9
Specifications	10
Preparation	10
Installing and removing the cycle computer	14
Turning the power ON / OFF	15
Basic screen display	16
Changing assist mode	20
Switching to [WALK] mode (walk assist mode).....	22
Switching the travel data display (SC-E8000/SC-E6010)	26
Switching the travel data display (SC-E6100)	28
Switching the travel data display (SC-E7000)	30
About the setting menus.....	32
Settings (EW-EN100)	54
RD protection reset	54
Adjust.....	54
Drive unit setting data backup function (SC-E8000/SC-E6010)	55
Connection and communication with devices	55
About wireless functions.....	56
Troubleshooting	57
Error messages on the cycle computer	57
Troubleshooting	61

IMPORTANT NOTICE

- Contact the place of purchase or a distributor for information on installation, adjustment, and replacement of the products which are not found in the user's manual. A dealer's manual for professional and experienced bicycle mechanics is available on our website (<https://si.shimano.com>).
- Use the product according to local laws and regulations.
- The Bluetooth® word mark and logos are registered trademarks owned by the Bluetooth SIG, Inc. and any use of such marks by SHIMANO INC. is under license. Other trademarks and trade names are those of their respective owners.

For safety, be sure to read this "user's manual" thoroughly before use, follow it for correct use, and store it so that it can be referenced at any time.

Important safety information

WARNING

- Do not disassemble or modify the product. This may cause the product to not operate correctly, and you may suddenly fall and be seriously injured.

To ensure safety

- Be sure to observe the following in order to avoid burns or other injury from fluid leakages, overheating, fire or explosions.

DANGER

Handling the battery

- Do not deform, modify, disassemble or apply solder directly to the battery. Doing so may cause leakage, overheating, bursting, or ignition of the battery.
- Do not leave the battery near sources of heat such as heaters. Doing so may cause bursting or ignition of the battery.
- Do not heat the battery or throw it into a fire. Doing so may cause bursting or ignition of the battery.

- Do not subject the battery to strong shocks or throw it. If this is not observed, overheating, bursting, or fire may occur.
- Do not place the battery into fresh water or sea water, and do not allow the battery terminals to get wet. Doing so may cause overheating, bursting, or ignition of the battery.
- Use the SHIMANO specified charger and observe the specified charging conditions when charging the specified battery. Not doing so may cause overheating, bursting, or ignition of the battery.

WARNING

To ensure safe riding

- Do not give too much of your attention to the cycle computer display while riding, otherwise accidents may result.
- Check that the wheels are securely installed to the bicycle before commencing riding. If the wheels are not securely installed, the bicycle may fall over and cause serious injury.
- If riding a power-assisted bicycle, make sure that you are fully familiar with the starting-off characteristics of the bicycle before riding it on roads with several vehicle lanes and pedestrian footpaths. If the bicycle starts off suddenly, accidents may result.
- Check that the bicycle lights illuminate before riding at night.

Using the product safely

- Be sure to remove the battery and charging cable before wiring or attaching parts to the bicycle. Otherwise, an electric shock may result.
- When charging the battery while it is installed on the bicycle, do not move the bicycle. The power plug for the battery charger may come loose and not be fully inserted into the electrical outlet, resulting in risk of fire.
- Do not touch the drive unit when it has been continuously used for a long period of time. The surface of the drive unit becomes hot and could cause burns.
- Periodically clean the chain using an appropriate chain cleaner. The frequency of maintenance will vary depending on the riding conditions.
- Do not use alkaline or acidic cleaning agents for removing rust under any circumstances. If such cleaning agents are used, they may damage the chain and serious injury may result.

- When installing this product, be sure to follow the instructions given in the user's manual. Furthermore, it is recommended that you use only genuine SHIMANO parts at these times. If bolts and nuts are left loosened or the product is damaged, the bicycle may suddenly fall over and serious injury may result.
- This appliance is not intended for use by persons (including children) with reduced physical, sensory or mental capabilities, or lack of experience and knowledge, unless they have been given supervision or instruction concerning use of the appliance by a person responsible for their safety.

Handling the battery

- If any liquid leaking from the battery gets into your eyes, immediately wash the affected area thoroughly with clean water such as tap water without rubbing your eyes, and seek medical advice immediately. If this is not done, the battery liquid may damage your eyes.
- Do not recharge the battery in places with high humidity or outdoors. Doing so may result in electric shock.
- Do not insert or remove the plug while it is wet. If this is not observed, electric shocks may result. If there is water leaking out of the plug, dry it thoroughly before inserting it.
- If the battery does not become fully charged even 2 hours after the designated charging time, immediately unplug the battery from the outlet and contact the place of purchase. Doing otherwise may cause it to overheat, burst, or ignite. Refer to the battery charger user's manual for the designated charging time of the battery.
- Do not use the battery if it has any noticeable scratches or other external damage. Doing so may cause bursting, overheating or problems with operation.
- The operating temperature ranges for the battery are given below. Do not use the battery in temperatures outside these ranges. If the battery is used or stored in temperatures outside these ranges, fire, injury or problems with operation may occur.
 1. During discharge: -10°C - 50°C
 2. During charging: 0°C - 40°C



To ensure safe riding

- Observe the instructions in the user's manual for the bicycle, in order to ride safely.

Using the product safely

- Never attempt to modify the system yourself. It may cause problems with system operation.
- Periodically check the battery charger and adapter, particularly the cord, plug, and case, for any damage. If the charger or adapter is broken, do not use it until it has been repaired.

Handling the battery

- Do not leave the battery in a place exposed to direct sunlight, inside a vehicle on a hot day, or other hot places. This may result in battery leakage.
- If any leaked fluid gets on your skin or clothes, wash it off immediately with clean water. The leaked fluid may damage your skin.
- Store the battery in a safe place out of the reach of infants and pets.

NOTICE

Using the product safely

- If any malfunctions or other problems occur, contact the place of purchase.
- Be sure to install caps to any connectors which are not being used.
- For installation and adjustment of the product, consult a dealer.
- The Product is designed to be fully waterproof to withstand wet weather riding conditions. However, do not deliberately place them into water.
- Do not clean the bicycle in a high-pressure wash. If water gets into any of the components, operating problems or rusting may result.
- Do not turn the bicycle upside down. The cycle computer or the shifting switch may get damaged.
- Handle the product carefully, and avoid subjecting it to any strong shocks.
- Although the bicycle still functions as a normal bicycle even when the battery is removed, the light does not turn on if it is connected to the electric power system. Be aware that using the bicycle under these conditions will be considered non-observance of the road traffic laws in Germany.
- When charging the battery while it is mounted on the bicycle, be careful of the following:
 - When charging, make sure there is no water on the charging port or the charger plug.
 - Ensure that the battery is locked into the battery mount before charging.

- Do not remove the battery from the battery mount while charging.
- Do not ride with the charger mounted.
- Close the charging port cap when not charging.
- Stabilize the bicycle to ensure that it does not collapse during charging.

Handling the battery

- When you carry a power-assisted bicycle in a car, remove the battery from the bicycle and place the bicycle on a stable surface in the car.
- Before connecting the battery, make sure that there is no buildup of water or dirt in the connector where the battery will be connected.
- The use of a genuine SHIMANO battery is recommended. If using a battery from another manufacturer, make sure to carefully read the owner's manual for the battery before use.

About used batteries

Disposal information for countries outside the European Union



This symbol is only valid within the European Union. Follow local regulations when disposing of used batteries. If you are not sure, consult the place of purchase or a bicycle dealer.

Connection and communication with PC

A PC linkage device can be used to connect a PC to the bicycle (system or components), and E-TUBE PROJECT can be used to carry out tasks such as customizing single components or the whole system and updating firmware.

- PC linkage device: SM-PCE1/SM-PCE02
- E-TUBE PROJECT: PC application
- Firmware: software inside each component

Connection and communication with smartphone or tablet

It is possible to customize single components or the system, and update firmware, using E-TUBE PROJECT for smartphones/tablets after connecting the bicycle (system or components) to a smartphone or tablet via Bluetooth LE.

- E-TUBE PROJECT: app for smartphones/tablets
- Firmware: software inside each component

Care and maintenance

- The number found on the battery mount key is necessary when purchasing spare keys. Keep it in a safe place. There is a space to enter the key number on the back cover of this user's manual. Enter the key number for safekeeping and later reference.
- Contact the place of purchase for updates of the product software. The most up-to-date information is available on the SHIMANO website. For details, refer to the "Connection and communication with devices." section.
- Do not use thinner or other solvents to clean any of the products. As such substances may damage the surfaces.
- You should periodically wash the chainrings in a neutral detergent. In addition, cleaning the chain with neutral detergent and lubricating it can be an effective way of extending the useful life of the chainrings and the chain.
- Use a damp cloth, with the water well wrung out, when cleaning the battery and plastic cover.
- For any questions regarding handling and maintenance, contact the place of purchase.
- Products are not guaranteed against natural wear and deterioration from normal use and aging.
- For maximum performance we highly recommend SHIMANO lubricants and maintenance products.

Assist

- If the settings are not correct, for instance if the chain tension is too tight, the proper assist force may not be obtained. If this happens, contact the place of purchase.

Label

- Some of the important information contained in this user's manual is also indicated on the battery charger label.

Inspection prior to each ride

Check the following before riding the bicycle.

- Is the drivetrain shifting smoothly?
- Is there looseness or damage on the component parts?
- Is the component mounted securely to the frame/handlebar/stem?
- Is there abnormal noise during riding?
- Is the battery sufficiently charged?

If you notice any potential problem, please contact the place of purchase or a bicycle dealer.

Please avoid wearing clothes that can get caught in the chain or wheel because it can lead to an accident.

FCC compliance information

This device complies with part 15 of the FCC Rules.

Operation is subject to the following two conditions:

- (1) This device may not cause harmful interference, and
- (2) this device must accept any interference received, including interference that may cause undesired operation.

NOTICE: This equipment has been tested and found to comply with the limits for a Class B digital device, pursuant to part 15 of the FCC Rules. These limits are designed to provide reasonable protection against harmful interference in a residential installation. This equipment generates, uses and can radiate radio frequency energy and, if not installed and used in accordance with the instructions, may cause harmful interference to radio communications. However, there is no guarantee that interference will not occur in a particular installation. If this equipment does cause harmful interference to radio or television reception, which can be determined by turning the equipment off and on, the user is encouraged to try to correct the interference by one or more of the following measures:

- Reorient or relocate the receiving antenna.
- Increase the separation between the equipment and receiver.
- Connect the equipment into an outlet on a circuit different from that to which the receiver is connected.
- Consult the dealer or an experienced radio/TV technician for help.

Booklet Structure

SHIMANO STEPS user's manuals are split among several booklets, as described below.

- **SHIMANO STEPS user's manual (this document)**

This is the basic user's manual for SHIMANO STEPS. It contains the following content.

- SHIMANO STEPS quick guide
- How to read the cycle computer and configure settings
- How to operate assist bicycles that use flat handlebars, such as city, trekking, or MTB type bicycles
- How to handle errors displayed on the cycle computer and perform other troubleshooting tasks

- **SHIMANO STEPS user's manual for drop handlebar bicycles (separate booklet)**

This booklet describes how to operate assist bicycles that use a drop handlebar and are controlled using a dual control lever. This should be read along with the SHIMANO STEPS user's manual.

- **SHIMANO STEPS special battery and parts user's manual**

It contains the following content.

- How to charge and handle the SHIMANO STEPS special battery
- How to attach and remove the SHIMANO STEPS special battery to the bicycle
- How to use the satellite power button and satellite charging port
- How to read the battery LEDs when charging or during an error, and how to handle errors

Be sure to read these user's manuals thoroughly before use, and follow it for correct use. Store the user's manuals so that they can be referenced at any time.

The latest user's manuals are available on our website (<https://si.shimano.com>).

Features of SHIMANO STEPS

- Hi-End MTB assistance components.
 - Powerful propulsion and silent drive unit.
 - Smooth and natural power assistance and riding experience.
 - Support optimal suspension design afforded by compact drive unit construction. Shorter chain stay frame gives rider easier handling.
 - Assist power stopped simultaneously with the stop of the rider's pedaling. Quickly re-start assistance upon pedaling again. Power assist system cooperates and harmonizes with human output.
 - Superior control performance facilitates comfortable riding on mountain trails.
 - Efficient pedaling even when power assist cuts off.
 - Easy to operate assist switch system designed in accordance with ergonomic principles.
 - Cycle computer that is compact without loss in visual clarity provides detailed traveling data by color recognition.
 - Q-Factor comparable to mountain bikes reduces burden on the legs from the MTB rider's experiences.
 - Optional chain device supports for rough riding conditions available.
 - Large-capacity battery allows you to enjoy long rides.
 - Intelligent [WALK] assist with SEIS RD provides powerful assistance when walking the bicycle across uneven terrain such as rocky areas.
- * The Walk assist mode function may not be able to be used in certain regions.

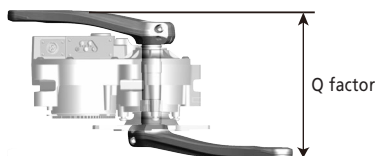

■ Riding the bicycle

1. Turn on the power.

- Do not place your feet on the pedals when turning the power on. A system error may result.
- Power cannot be turned on while charging.

2. Select your preferred assist mode.

3. Assistance will start when the pedals start turning.



4. Change the assist mode in accordance with the riding conditions.

5. Turn the power off when parking the bicycle.

- Do not place your feet on the pedals when turning the power off. A system error may result.

■ Assist mode

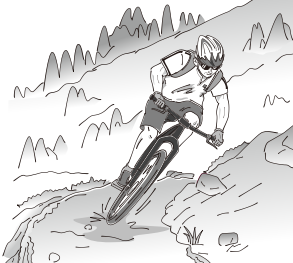
You can select an assist mode for each particular application.

[BOOST]	[TRAIL]	[ECO]
		
<p>Use when powerful assistance is required, such as when riding up steep uphill slopes. This mode is designed for use on steep inclines and precipitous mountains. When riding on level public roads with traffic lights, the assistance provided may be excessive, in which case, switch to [ECO] mode.</p>	<p>Use when an intermediate level of assistance is needed, such as when you want to enjoy riding comfortably on a gentle slope or level ground.</p>	<p>Use when you want to enjoy long distance riding on level ground. When pedaling is not very strong, the amount of assistance is reduced and energy consumption is lessened.</p>
<p>When the battery level is running low, the level of assistance is lowered to increase the traveling range.</p>		
<p style="text-align: center;">[OFF]</p>		
<p>This mode does not provide power assistance when the power is turned on. Since there is no power consumption associated with the power assistance, it is useful for reducing battery consumption when the battery is running low.</p>		
<p style="text-align: center;">[WALK]</p>		
		
<p>This mode is particularly useful when walking the bicycle, taking the bicycle out up an incline or when it is bearing a heavy load. It is also useful when walking the bicycle across uneven terrain such as rocky areas. The intelligent walk assist function activates when an electric shifting system such as XTR, DEORE XT SEIS is connected. System individually supplies assist power to detect gear position.</p> <p>"Intelligent walk assist" support rider more torque output in steep climb condition in lower side gears.</p> <p>"Quick walk assist" function works quickly by holding down SW from any mode.</p> <p>* The Walk assist mode function may not be able to be used in certain regions.</p>		

Names of parts

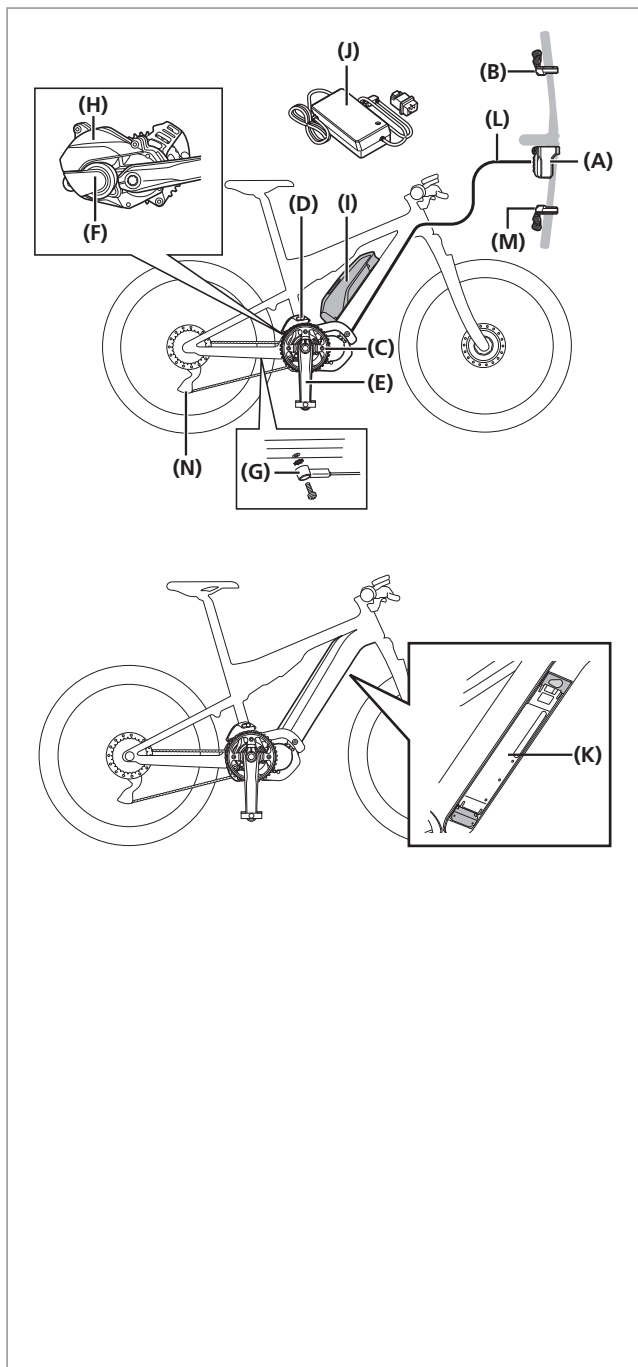

- (A)** Cycle computer/Junction [A]:
 SC-E8000
 SC-E6010
 SC-E6100
 SC-E7000
 EW-EN100
- (B)** Assist switch:
 SW-E8000-L
 SW-E6000
 SW-E6010
 SW-E7000
- (C)** Front chainring:
 SM-CRE80
 SM-CRE80-B
 SM-CRE80-12-B
- (D)** Chain device:
 SM-CDE80
- (E)** Crank arm:
 FC-E8000
 FC-E8050
 FC-M8050
- (F)** Drive unit:
 DU-E8000
- (G)** Speed sensor:
 SM-DUE10
- (H)** Drive unit cover:
 SM-DUE80-A/SM-DUE80-B
- (I)** Battery (external type)/
 Battery mount (external type):
 BT-E8010
 BM-E8010
 BT-E6010
 BM-E6010
- (J)** Battery charger:
 EC-E6000
- (K)** Battery (built-in type)/
 Battery mount (built-in type):
 BT-E8020
 BM-E8020
- (L)** E-TUBE(EW-SD50)
- When using electronic gear shifting**
- (M)** Shifting switch:
 SW-M9050-R
 SW-M8050-R
 SW-E6010
 SW-E7000
- (N)** Rear derailleur (DI2):
 RD-M9050
 RD-M8050

Specifications

Operating temperature range: During discharge	-10 – 50°C	Battery type	Lithium ion battery
Operating temperature range: During charging	0 – 40°C	Nominal capacity	Please read the SHIMANO STEPS special battery and parts user's manual.
Storage temperature	-20 – 70°C	Rated voltage	36 V DC
Storage temperature (Battery)	-20 – 60°C	Drive unit type	Midship
Charging voltage	100 – 240 V AC	Motor type	Brush-less DC
Charging time	Please read the SHIMANO STEPS special battery and parts user's manual.	Rated drive unit power	250 W

* The maximum speed up to which power assistance is provided is set by the manufacturer and is conditional on where the bicycle is to be used.

Preparation

You cannot use the battery immediately after shipment.

The battery can be used after charging it with the designated charger.

Be sure to charge it before use. The battery can be used when the LED on it lights up.

Please read the SHIMANO STEPS special battery and parts user's manual for how to charge and handle the battery.

Cycle computer and switch units

SC-E8000/SW-E8000-L/SW-M8050-R (SW-M9050-R)

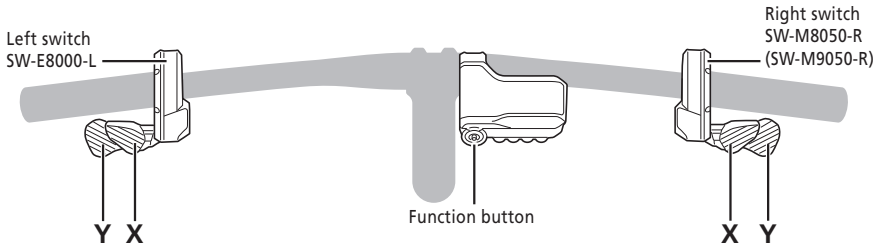

SC-E6010/SW-E6000

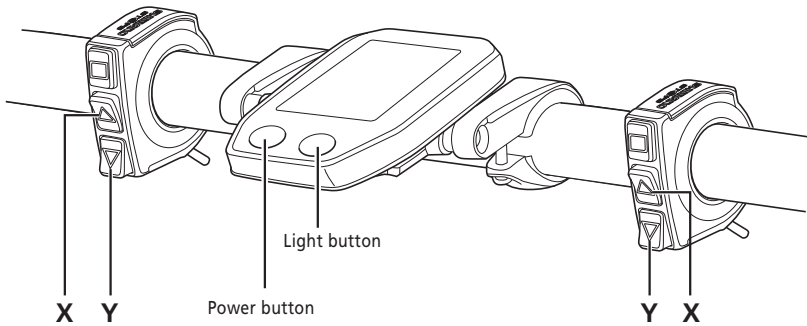

SC-E6010/SW-E6010

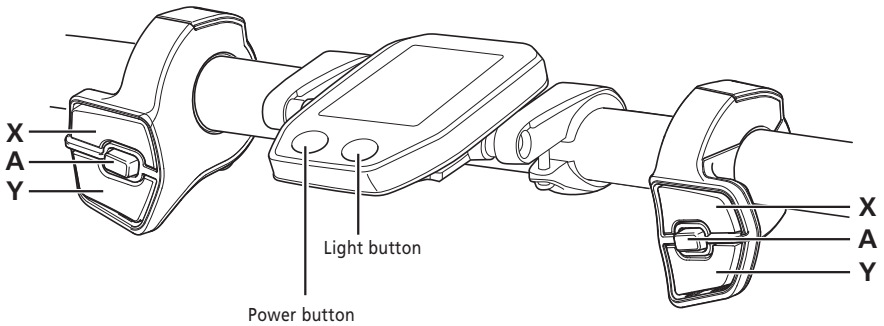

SC-E6100/SW-E6010

Left switch

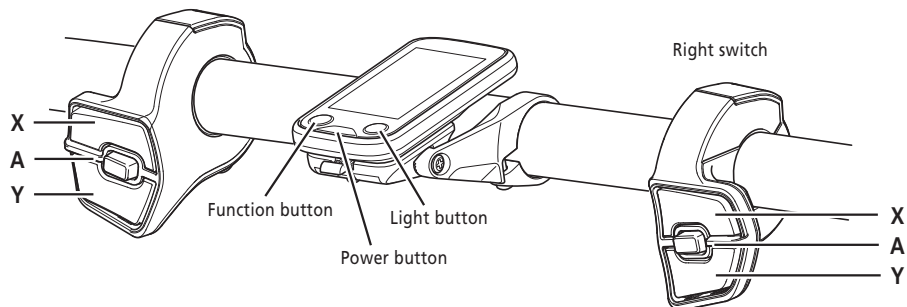

SC-E7000/SW-E7000

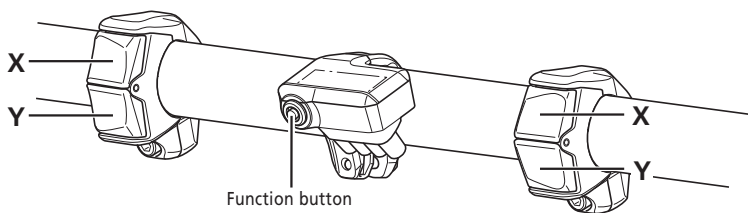

Left switch (default: for assistance)		Right switch (default: for electronic shifting)	
Assist-X	At riding: increase assistance. At setting: move the setting menu cursor, adjust settings, etc.	Shift-X	At riding: shift up.
Assist-Y	At riding: decrease assistance. At setting: move the setting menu cursor, adjust settings, etc.	Shift-Y	At riding: shift down.
Assist-A	At riding: change the travel data display on the cycle computer. At setting: switch between the screens, confirm settings.	Shift-A	Not used.

Cycle computer (SC-E6010/SC-E6100)			
Function button (SC-E6100)	At riding: change the travel data display on the cycle computer. At setting: switch between the screens, confirm settings.	Light button	Turn the lights ON/OFF.
		Power button	Turn the power ON/OFF.

Cycle computer (SC-E8000/SC-E7000)	
Function button	At riding: change the travel data display on the cycle computer. At setting: switch between the screens, confirm settings.

Junction [A] (EW-EN100)

EW-EN100 is used instead of cycle computer.

It is attached to the brake outer casing or brake hose and located near the handle bar.

- The button does not recommend operating this unit while riding the bicycle. Please select your preferred assist mode before riding.
- For other functions assigned to the button, see "Settings (EW-EN100)."

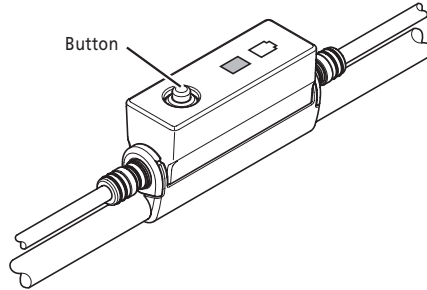

Junction [A]

Button

Press: change the assist mode each time you press it.
Press and hold (about 2 seconds): turn the light ON/OFF

■ Installing and removing the cycle computer

SC-E6010/SC-E6100

Slide the cycle computer onto the bracket as shown in the illustration to install it.

Insert the cycle computer securely until it clicks into place.

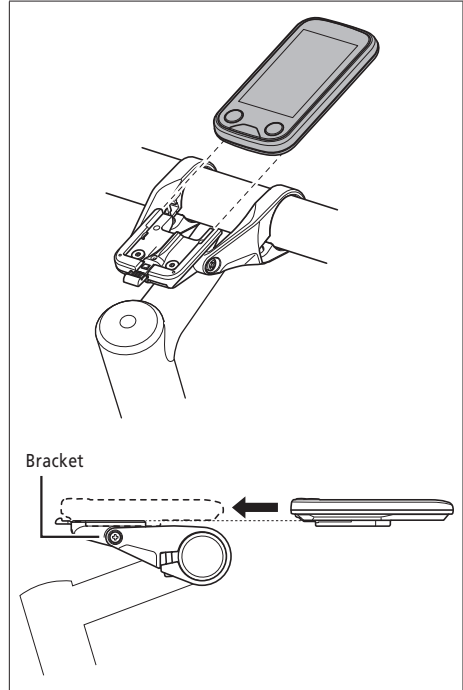

To remove the cycle computer, slide it while pushing the bracket lever downward.

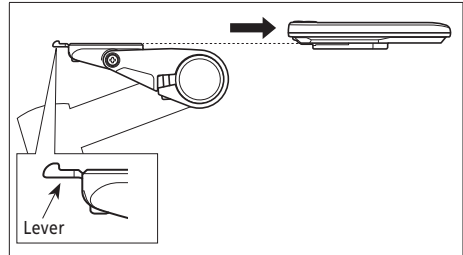

If the cycle computer is not correctly in place, the assist function will not operate normally.

For details on installing SC-E8000/SC-E7000, consult the place of purchase or a bicycle dealer.

■ Turning the power ON / OFF

Automatic power off function

If the bicycle has not moved for over 10 minutes, the power will automatically turn off.

Turning the power ON and OFF via the battery

BT-E8010/BT-E8020/BT-E6010

Press the power button on the battery. The LED lamps will light up indicating remaining battery capacity.

NOTICE

- When turning on the power, check that the battery is firmly attached to the holder.
- Power cannot be turned on while charging.
- Do not place your foot on the pedals when turning on. A system error may result.



BT-E8010/BT-E8020 can be forced to power off by holding down the power button for 6 seconds.

BT-E8010

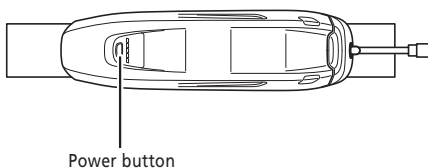

BT-E8020

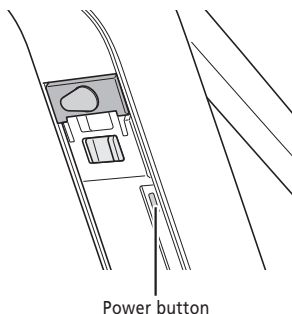

BT-E6010

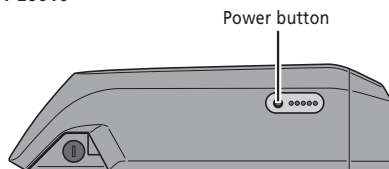

Turning the power ON and OFF via the cycle computer

SC-E6010

- Hold down the power button on the cycle computer for 2 seconds.

SC-E6100

- Press the power button on the cycle computer.

NOTICE

If built-in battery of cycle computer isn't charged sufficiently, the power will not turn on.
The built-in battery of the cycle computer is charged only when the cycle computer screen is on.

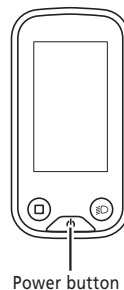
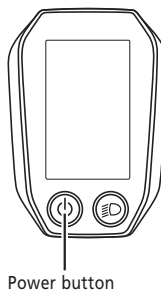

SHIMANO STEPS logo screen

This screen is displayed during system start up and shutdown.



For SC-E6100, the screen shown on the right is displayed when the battery level is low.



EW-EN100

The LED2 turns ON.

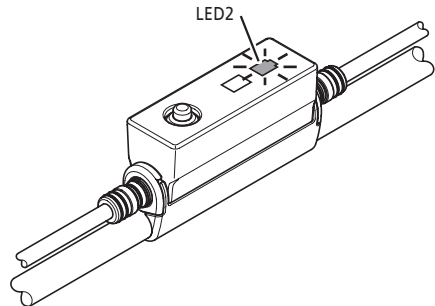

■ Basic screen display

Displays the status of the power assisted bicycle, traveling data.

The cycle computer screen is shown as follows in this owner's manual.

- The SC-E8000 screen is used when explaining SC-E8000, SC-E6010, SC-E6100, and SC-E7000, except in cases where the cycle computer display is significantly different.
- The SC-E8000 screen is used when explaining SC-E8000 and SC-E7000, except in cases where the cycle computer display is significantly different.
- The SC-E6100 screen is used when explaining SC-E6010 and SC-E6100, except in cases where the cycle computer display is significantly different.

- (A) Battery level indicator**
Displays the current battery level.
- (B) Gear position (Only displays when electronic gear shifting is in use)**
Displays the currently set gear position.
 - Current gear position(SC-E6010/SC-E6100)
 - Shifting advice*1(SC-E6100)
 - This notifies you of the recommended timing at which to shift based on the bicycle riding conditions.
- (C) Assist gauge**
Displays assistance level.
- (D) Current assist mode**
- (E) Current speed*2**
Displays the current speed.
The display can be switched between km/h and mph.
- (F) Current time**
Shows the current time.
- (G) Light icon**
Indicates that the light connected to the drive unit is lit.
- (H) Traveling data display**
Displays the current traveling data.
- (I) Maintenance alert**
Indicates that maintenance is required. Contact your place of purchase or a bicycle dealer if this icon is displayed.
- (J) Bluetooth® LE icon**
Displayed when connected over Bluetooth LE.

*1 Electronic gear shifting only.

*2 For SE-E7000, the traveling data displayed in this location can be changed.

SC-E8000

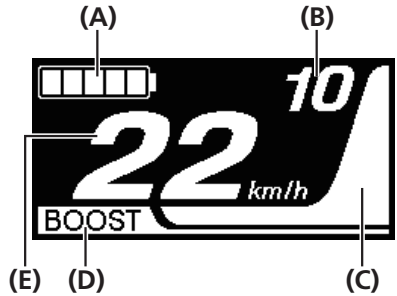

SC-E6010

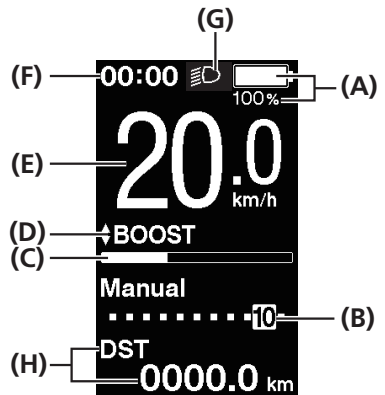

SC-E6100

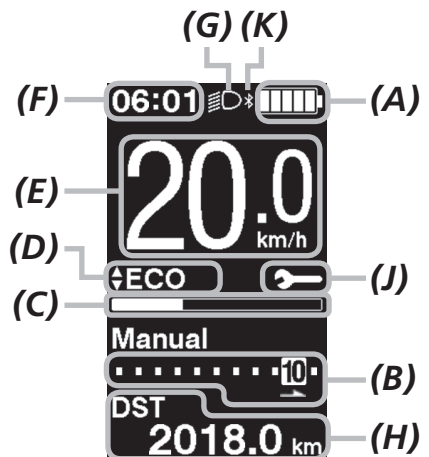

SC-E7000

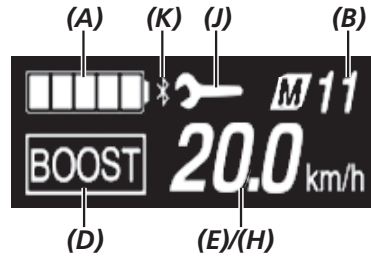

EW-EN100

LED lamps indicate the following status.

- Current battery level
- Current assist mode



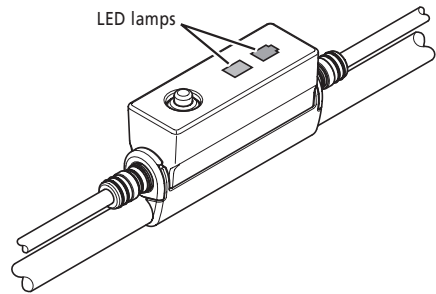



For details, see "Battery level indicator" and "Changing the assist mode".



Battery level indicator





You can check the battery level on the cycle computer while riding.

SC-E8000/SC-E6100/SC-E7000

Display	Battery level
	100 - 81%
	80 - 61%
	60 - 41%
	40 - 21%
	20 - 1%
	0%

* For SC-E8000/SC-E7000, the battery level indicator will flash when the battery level is low.

SC-E6010



Display	Battery level
	100%
	
	0%



The cycle computer and battery use zero to indicate a battery level where the entire system (including the lights which remain on after the assist function stops) ceases to function. Therefore, assist may stop before 0% is indicated, depending on the settings.

EW-EN100

While power is turned on, the LED2 indicates the battery level.

LED2 indication	Battery level
 (Lit in green)	100 - 21%
 (Lit in red)	20% or less
 (blink in red)	Only a few left

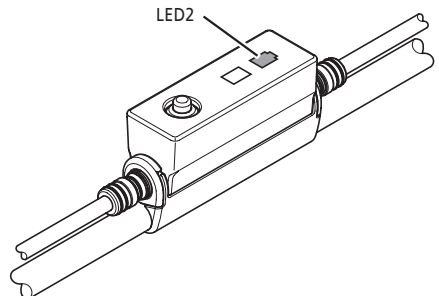

■ Changing assist mode

Press Assist-X or Assist-Y to switch assist modes.

If no assist switch is connected when using SC-E6100 or SC-E7000, you can also hold down the function button to switch to assist mode.

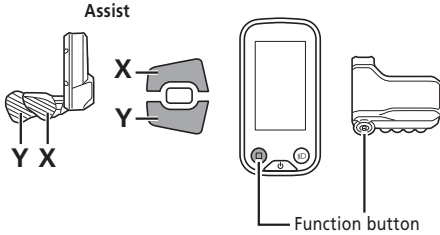

SC-E8000



SC-E6010



[BOOST]: Assist boost

[TRAIL]: Assist trail

[ECO]: Assist eco

[OFF]: Assist off

[WALK]: Walk assist

↑ : Short press Assist-X

↓ : Short press Assist-Y

⋮▶ : Long press Assist-Y

◀ : Short press Assist-X (This operation is for canceling [WALK] mode)

* The Walk assist mode function may not be able to be used in certain regions.

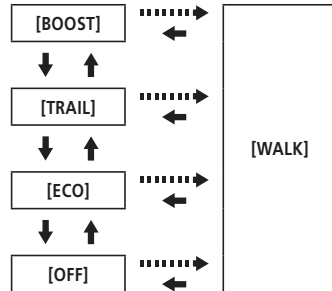

EW-EN100

1. Press button.

Assist mode is changed each time you press it.

The LED1 indicates current assist mode.

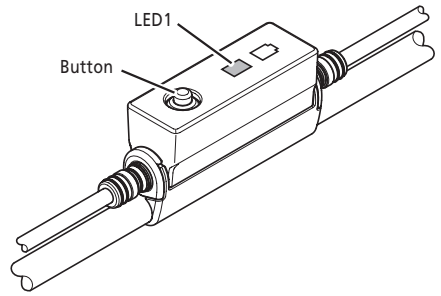
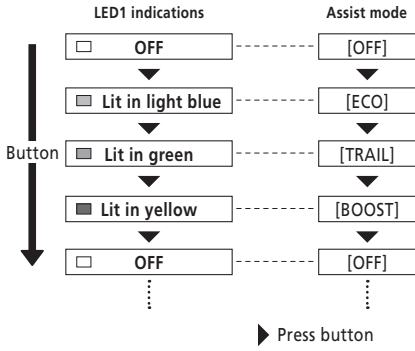

■ Switching to [WALK] mode (walk assist mode)

- If Assist-Y is not pressed for one minute or more, the mode active before [WALK] mode was set, is re-activated.
- If the bicycle is not moved after [WALK] mode is activated, walk assist is automatically inactivated. To re-activate [WALK] mode, momentarily release Assist-Y and then hold down Assist-Y.
- The walk assist function can operate at a maximum of 6 km/h.
- The assistance level and speed vary with the gear position.
- The intelligent walk assist function activates when an electric shifting system such as XTR, DEORE XT SEIS is connected. System individually supplies assist power to detect gear position.
"Intelligent walk assist" support rider more torque output in steep climb condition in lower side gears.
"Quick walk assist" function works quickly by holding down SW from any mode.

Switching to walk assist mode

* The Walk assist mode function may not be able to be used in certain regions.

1. With your feet off the pedals and current speed at [0 km/h], hold down Assist-Y until [WALK] displays.

- EW-EN100: LED1 lights up blue.

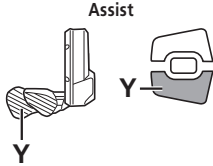

NOTICE

A warning tone will sound while switching is in progress if it is not possible to switch to [WALK] mode because the current speed is not [0 km/h] or there is pressure on the pedals etc.

SC-E8000



SC-E6010



EW-EN100

Assist OFF

Walk assist mode
enabled

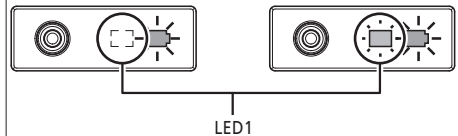

Walk assist mode operation

1. Continue to press Assist-Y while in walk assist mode.

- Walk assist will function only while Assist-Y is pressed.
- If a switch unit is connected to EW-EN100, the LED1 will flash blue when walk assist starts.

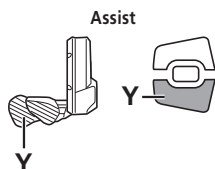

SC-E6100

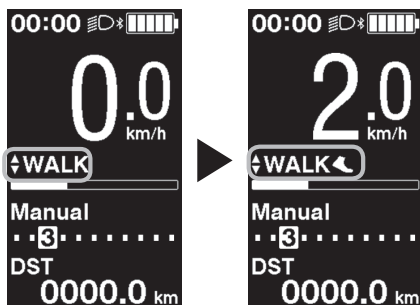

EW-EN100

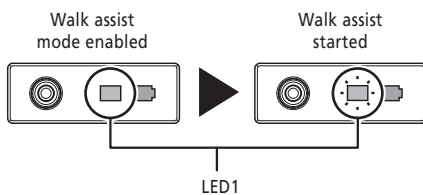

2. Carefully push the bicycle together with walk assist.

3. Removing your finger from Assist-Y will stop walk assist.

SC-E6100

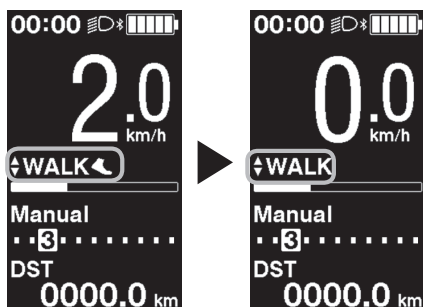

EW-EN100

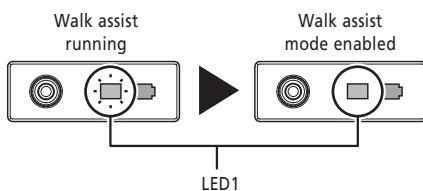

4. Press Assist-X to exit walk assist mode.

- When [WALK] mode is canceled, the mode active before [WALK] mode was set, is re-activated.

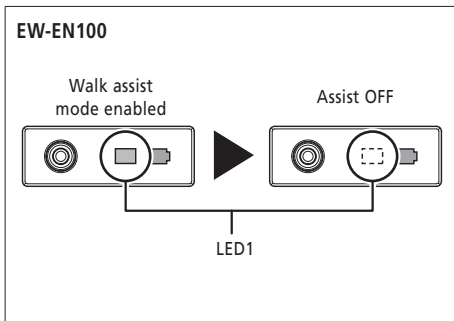
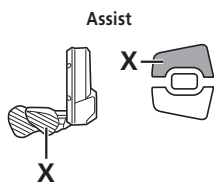

■ Switching the travel data display (SC-E8000/SC-E6010)

* The Walk assist mode function may not be able to be used in certain regions.

The type of travel data displayed changes each time you press Assist-A or the cycle computer's function button.

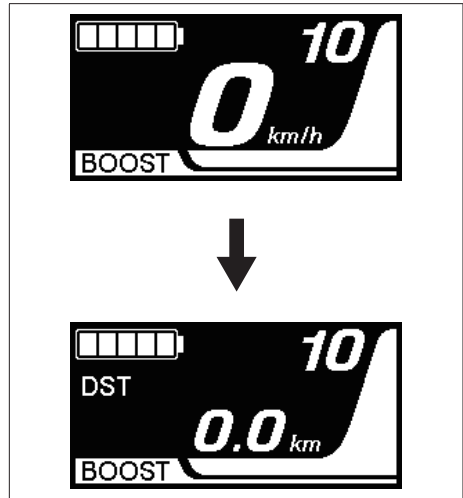
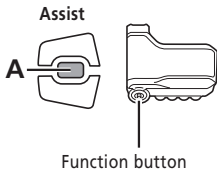

- (A) Traveling distance
- (B) Cumulative distance
- (C) Traveling range *1, 2
- (D) Traveling time *3
- (E) Average speed *3
- (F) Maximum speed *3
- (G) Number of crank rotations *3
- (H) Current time *3

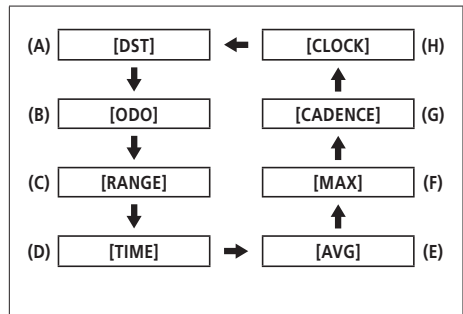

*1 When [RANGE] is displayed, the battery level is not displayed. The traveling range should be used as a reference only.

*2 When walk assistance is functioning, the on screen display [RANGE] changes to [RANGE ---].

*3 Optional item: You can configure the display settings in E-TUBE PROJECT. For details, refer to the "Connection and communication with devices." section.

*4 Displayed constantly on SC-E6010.

NOTICE

When traveling data is displayed, the screen returns to speed display after 60 seconds.

When speed data is displayed, pressing Assist-A or the function button changes the traveling data displayed starting with [DST].

Clearing the traveling distance (SC-E8000/SC-E6010)

You can clear the traveling distance in the main screen.

1. Change the traveling data display to [DST] and press Assist-A for 2 seconds.
2. Release the finger when the [DST] indication starts blinking.
In this state, pressing Assist-A again clears the traveling distance.



-
- The [DST] indicator light stops blinking and the screen takes you back to the basic screen after leaving it alone for 5 seconds.
 - When the traveling distance is cleared, [TIME] (traveling time), [AVG] (average speed), and [MAX] (maximum speed) are also cleared.
-

■ Switching the travel data display (SC-E6100)

* The Walk assist mode function may not be able to be used in certain regions.

The type of travel data displayed changes each time you press Assist-A or the cycle computer's function button.

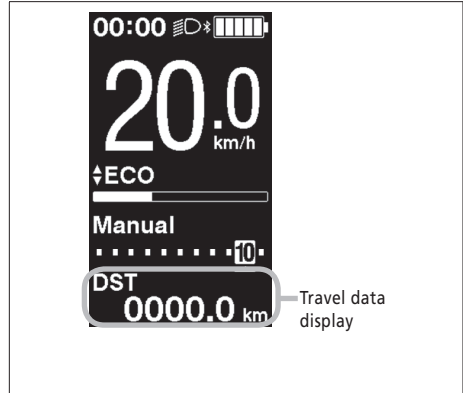
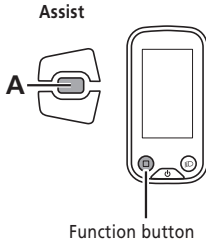

- (A) Traveling distance
- (B) Cumulative distance
- (C) Traveling range *1
- (D) Traveling range for each assist mode *1*2*3
- (E) Traveling time *3
- (F) Average speed *3
- (G) Maximum speed *3
- (H) Your crank rotation speed *3 *4

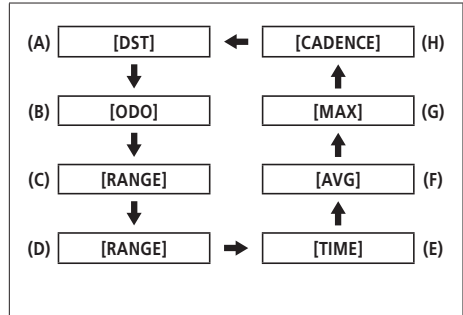

*1 The battery level is not displayed while displaying the traveling range. The traveling range should be used as a reference only.

*2 This data is displayed as follows. Gear shifting mode and gear position are not displayed.

RANGE	
HIGH	61 km
NORM	77 km
ECO	97 km

*3 Optional item: You can configure the display settings in E-TUBE PROJECT. For details, refer to the "Connection and communication with devices."

*4 Cadence is only displayed when pedaling is assisted while using electronic gear shifting.

Clearing the traveling distance (SC-E6100)

You can clear the traveling distance in the main screen. When the traveling distance is cleared, [TIME] (Traveling time), [AVG] (average speed), [MAX] (maximum speed) are also cleared.

1. Press Assist-A or function button to change the travel data display to [DST].

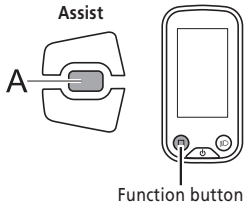

2. Press and hold down Assist-A or the function button until the value below the [DST] display blinks.

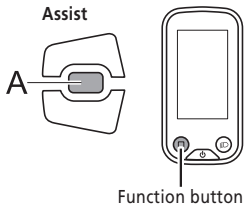

3. Press Assist-A or the function button again.
 - Travel data is cleared.
 - The [DST] value stops blinking and the screen takes resets to the basic screen after being left alone for 5 seconds.

■ Switching the travel data display (SC-E7000)

* The Walk assist mode function may not be able to be used in certain regions.

The type of travel data displayed changes each time you press Assist-A or the cycle computer's function button.

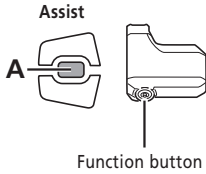

< Current speed display >



- (A) Current speed
- (B) Traveling distance
- (C) Cumulative distance
- (D) Traveling range *1
- (E) Traveling time *2
- (F) Average speed *2
- (G) Maximum speed *2
- (H) Number of crank rotations *2*3
- (I) Current time *2

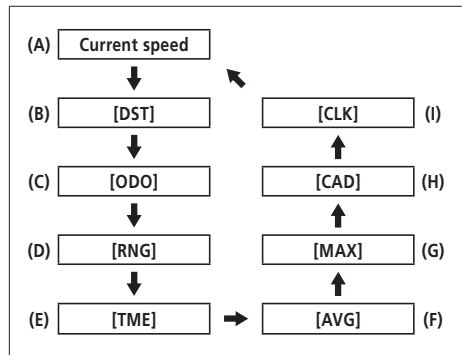

*1 The traveling range should be used as a reference only.

*2 Optional item: You can configure the display settings in E-TUBE PROJECT.

*3 Cadence is only displayed when pedaling is assisted while using electronic gear shifting.

Clearing the traveling distance (SC-E7000)

You can clear the traveling distance in the main screen. When the traveling distance is cleared, [TME] (Traveling time), [AVG] (average speed), and [MAX] (maximum speed) are also cleared.

- 1.** Press Assist-A or the function button to switch the traveling data display to [DST].
- 2.** Continue to hold Assist-A or the function button until the number displayed for [DST] flashes.
- 3.** Press Assist-A or the function button again.
 - The traveling data is cleared.
 - If nothing is done for five seconds after the number for [DST] begins flashing, it will stop flashing and the screen will return to the basic screen.

■ About the setting menus

Accessing the setting menu

1. Hold down the function button or Assist-X and Assist-Y when the bicycle is not moving to display the menu list screen.

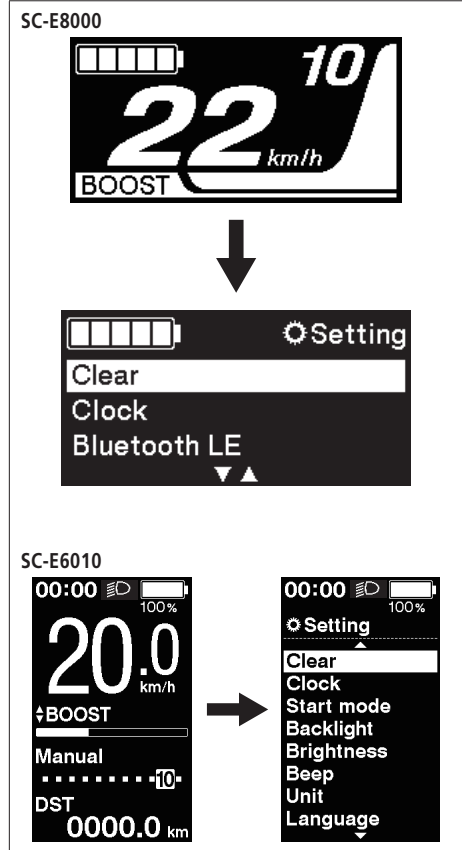
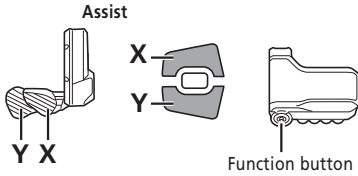

2. Press Assist-X or Assist-Y to select the various menus.
Press the function button to display the setting screen for the selected menu.

SW-E8000-L/SC-E8000

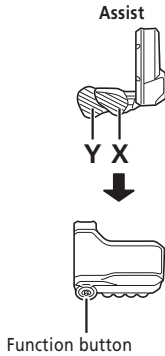

- (A) Clear settings
- (B) Clock setting
- (C) Bluetooth LE pairing
- (D) Bluetooth LE/ANT connection status
- (E) Turning the light on/off
- (F) Display backlight brightness setting
- (G) Turning the beep noise on/off
- (H) Switching between km and miles
- (I) Language setting
- (J) Adjusting the electronic gear shifting unit
- (K) Activating RD Protection Reset*
- (L) Return to the main screen

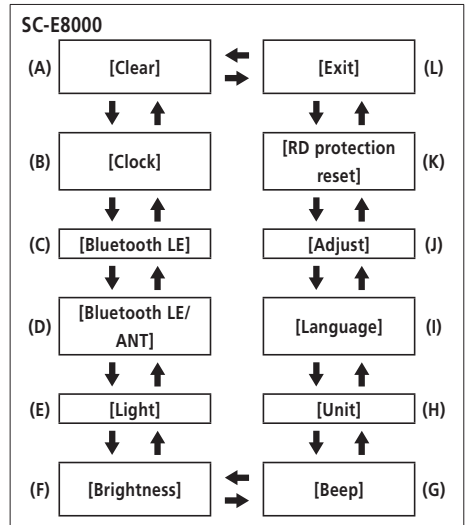

* In order to protect the system when the bicycle falls and is subjected to a strong impact, the RD Protection function will activate and momentarily sever the connection between the motor and the link, impairing the proper function of the rear derailleur. Executing RD Protection Reset restores the connection between the motor and the link, as well as the function of the rear derailleur.

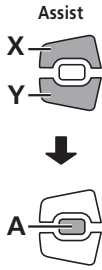

- (A)** Clear settings
- (B)** Clock setting
- (C)** Turning the display backlight on/off
- (D)** Display backlight brightness setting
- (E)** Turning the beep noise on/off
- (F)** Switching between km and miles
- (G)** Language setting
- (H)** Changing the font color
- (I)** Adjusting the electronic gear shifting unit
- (J)** Activating RD Protection Reset*
- (K)** Return to the main screen

[Start mode] and [Auto] are displayed on the menu list screen; however, they are not available for use.

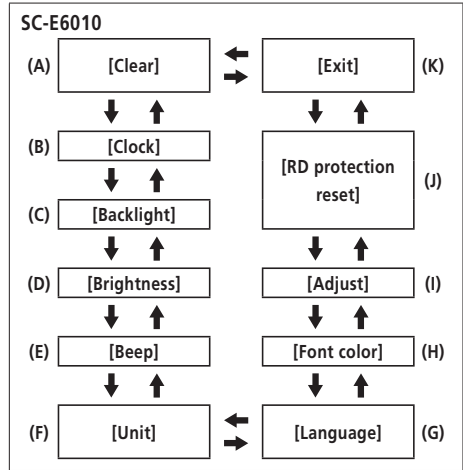

* In order to protect the system when the bicycle falls and is subjected to a strong impact, the RD Protection function will activate and momentarily sever the connection between the motor and the link, impairing the proper function of the rear derailleur. Executing RD Protection Reset restores the connection between the motor and the link, as well as the function of the rear derailleur.

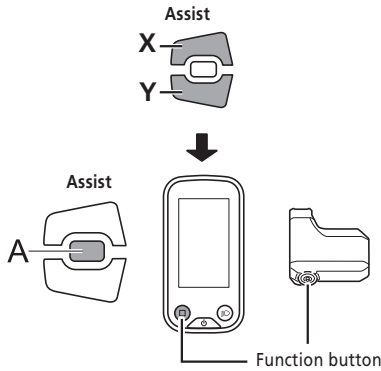

- (A)** Clear settings
- (B)** Clock setting
- (C)** Turning the display backlight on/off (SC-E6100)
- (D)** Display backlight brightness setting (SC-E6100)
- (E)** Turning the light on/off (SC-E7000)
- (F)** Turning the beep noise on/off
- (G)** Switching between km and miles
- (H)** Language setting
- (I)** Changing the font color
- (J)** Adjusting the electronic gear shifting unit
- (K)** Adjusting the timing at which gear shifting advice is displayed (SC-E6100)
- (L)** Adjusting the gear shifting timing (SC-E6100)
- (M)** Activating RD Protection Reset*
- (N)** Adjusts the displayed speed to match another device.
- (O)** Return to the main screen

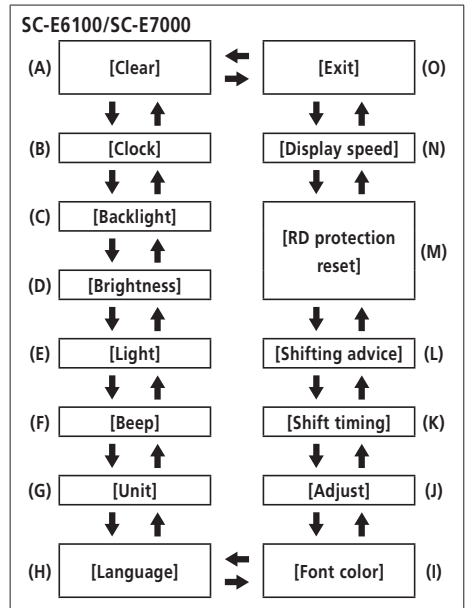

* In order to protect the system when the bicycle falls and is subjected to a strong impact, the RD Protection function will activate and momentarily sever the connection between the motor and the link, impairing the proper function of the rear derailleur. Executing RD Protection Reset restores the connection between the motor and the link, as well as the function of the rear derailleur.

[Clear] Setting reset

Reset the traveling distance to default.

1. Press Assist-X or Assist-Y to select [DST].

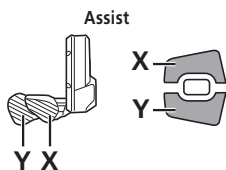

Configurable items	Details
[Exit]	Return to the menu list screen
[DST]	Reset the traveling distance
[Default]*1	Reset the display settings

*1 SC-E6010/SC-E6100 only

When the display settings are reset, the following will be reset to their default settings.

Configurable items	Default value
[Backlight]	ON
[Beep]	ON
[Unit]	km
[Language]	English
[Brightness]	3
[Font color]	White

SC-E8000



SC-E6010



2. To reset traveling distance, select [OK] using Assist-X or Assist-Y and press the function button to confirm. After resetting, the screen will automatically return to the menu list screen.

- A reset confirmation screen is not displayed on SC-E6010/SC-E7000/SC-E6100.

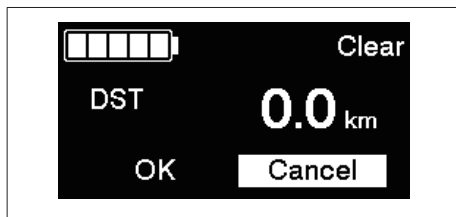
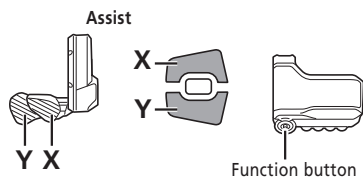

When the traveling distance is cleared, [TIME]/[TME] (Traveling time), [AVG] (average speed), and [MAX] (maximum speed) are also cleared.

[Clock] Time setting

Configure the clock setting.

1. Press Assist-X or Assist-Y to adjust the time.

- Press Assist-X to increase the numbers.
- Press Assist-Y to decrease the numbers.

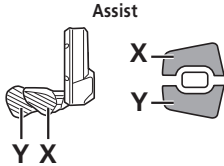

2. Pressing Assist-A or function button enables the set value and moves you to the minutes setting.

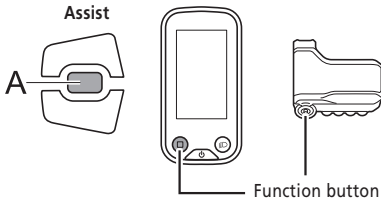

3. Press Assist-X or Assist-Y to set the minutes.

4. Press Assist-A or the function button to confirm the setting.

- After confirmation, the screen will automatically return to the menu list screen.



You can change the numbers quickly by holding down Assist-X or Assist-Y.

[Bluetooth LE] (SC-E8000)

E-TUBE PROJECT for smartphones/tablets may be used if a Bluetooth LE connection is established with a smartphone/tablet.

1. Before setting up a connection, turn on Bluetooth LE on the smartphone/tablet.
2. Open E-TUBE PROJECT and set it to listen for Bluetooth LE signals.
3. Press Assist-X or Assist-Y to select [Start].
To start Bluetooth LE pairing, press A or the function button to confirm.
 - If you press A or the function button during Bluetooth LE pairing, the transmission will be interrupted, then the screen will return to the menu list screen.

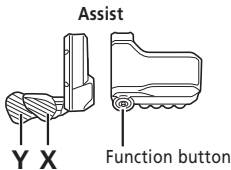

Configurable items	Details
[Start]	Starts Bluetooth LE pairing
[Cancel]	To not perform pairing, select [Cancel]

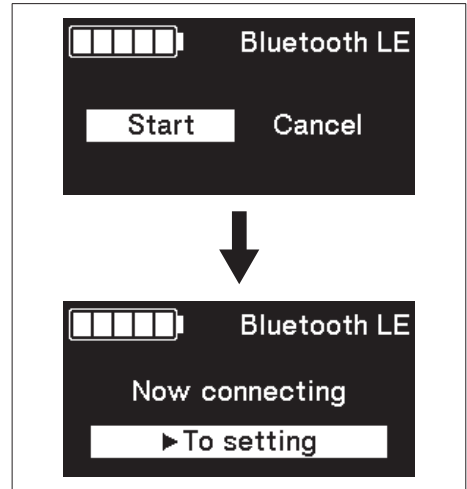

Generally, Bluetooth LE transmission will begin automatically when the cycle computer is turned on, however, pairing can be started by selecting [Start] from the [Bluetooth LE] menu when connectivity is poor.

- 4.** When connection is successful, SHIMANO STEPS logo is displayed on screen. If connection is not successful, a message indicating this is displayed.
- After successful connection or a connection failure, press one of Assist-X/Assist-Y/function button or the screen will automatically return to the menu list screen after awhile.

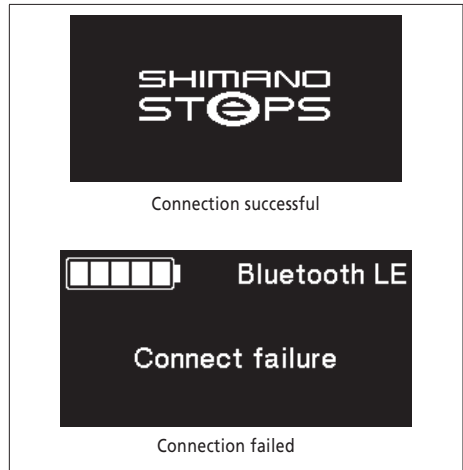

- 5.** When connection is successful, the unit name will display in E-TUBE PROJECT.
- 6.** Select the unit name displayed on screen.
- To disconnect, cancel the Bluetooth LE connection from the smartphone/tablet. (The cycle computer will exit connection mode and return to regular operation mode.)

[Bluetooth LE/ANT] (SC-E8000)

Current status of wireless connections can be displayed on screen.

For details on ANT connection, refer to "ANT connection" in the section "About wireless functions".

Select [Bluetooth LE/ANT] from the menu list screen and confirm to display current wireless connection status.

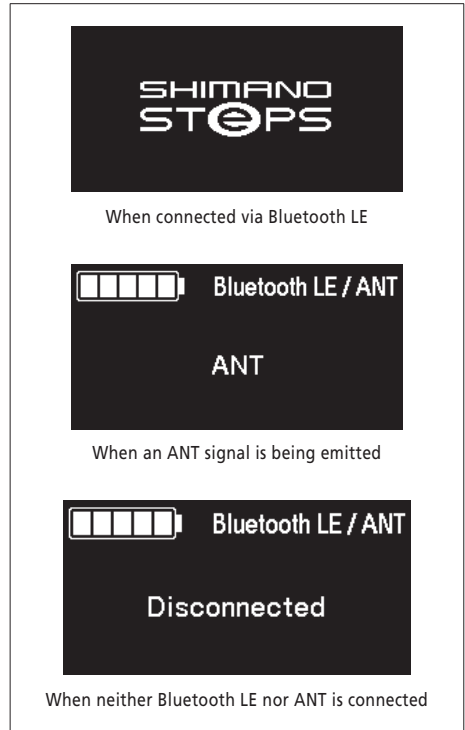

[Light] Light ON/OFF (SC-E8000/SC-E7000)

Turns the light connected to the drive unit ON/OFF.

1. Press Assist-X or Assist-Y to select the required setting.

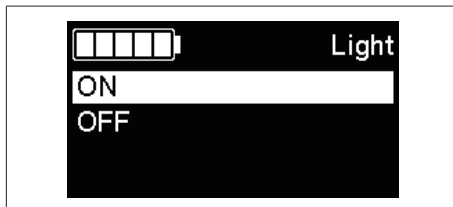
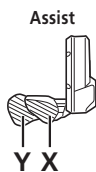

Configurable items	Details
[ON]	Keep light always on
[OFF]	Keep light always off

2. Press Assist-A or the function button to finalize the setting.

- After confirmation, the screen will automatically return to the menu list screen.

If using SW-E6010, this can also be operated with Assist-A.

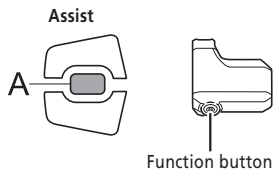

[Light] Light ON/OFF (SC-E6010/SC-E6100)

The light can be turned on by pressing the light button on the cycle computer when the light is connected. An icon indicating that the light is on appears on the screen. Push the button again to turn the light off. Once the light is turned off, the icon on the screen disappears.

- * When the battery powered light is not connected and [Backlight] is set to [MANUAL], pressing the light button turns the cycle computer's backlight on and off.
- * When using SC-E8000/SC-E7000, the light can be operated from the setting menu.

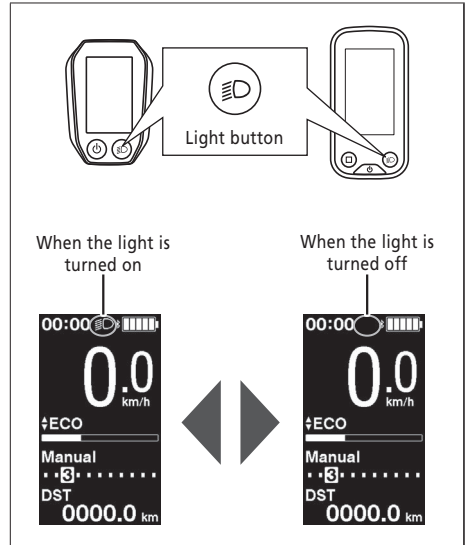

The light turns off when the power is turned OFF. The light will not turn on when the power is OFF.

[Backlight] backlight setting (SC-E6010/SC-E6100)

Configure the display backlight setting.

1. Press Assist-X or Assist-Y to select the required setting.



Configurable items	Details
[ON]	Keep light always on
[OFF]	Keep light always off
[MANUAL]	Turns the light connected to the drive unit ON/OFF.

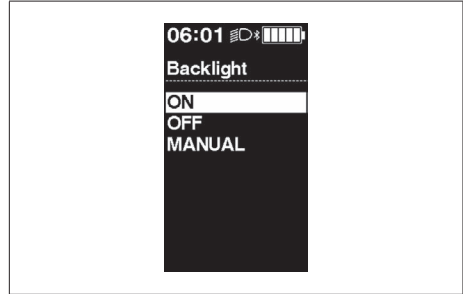

2. Press Assist-A or the function button to confirm the setting.
 - After confirmation, the screen will automatically return to the menu list screen.

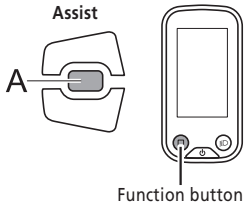

[Brightness] backlight brightness setting (SC-E8000/SC-E6010/SC-E6100)

The brightness of the backlight can be adjusted as needed.

1. Press Assist-X or Assist-Y to adjust the brightness.
 - The brightness can be adjusted in 5 levels.

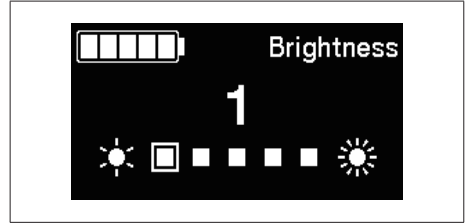
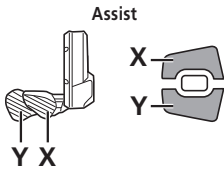

2. Press Assist-A or the function button to confirm the adjusted value.
 - After confirmation, the screen will automatically return to the menu list screen.

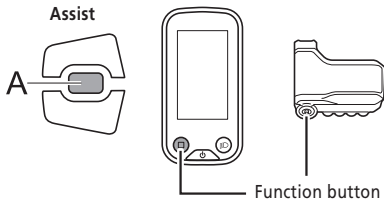

[Beep] Beep setting

The beep noise can be turned on/off.

1. Press Assist-X or Assist-Y to select the required setting.

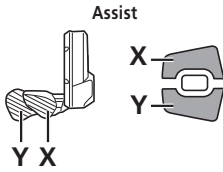

Configurable items	Details
[ON]	Enable beeps
[OFF]	Disable beeps

2. Press Assist-A or the function button to confirm the setting.

- After confirmation, the screen will automatically return to the menu list screen.

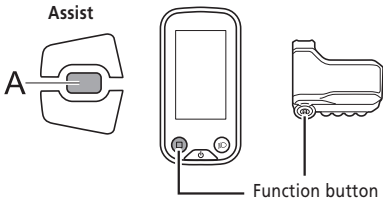

Even when [Beep] is set to [OFF], a beep will sound when there is a misoperation, system error, etc.

[Unit] Km/mile switch

Distance units (km/miles) can be switched.

1. Press Assist-X or Assist-Y to select the required setting.

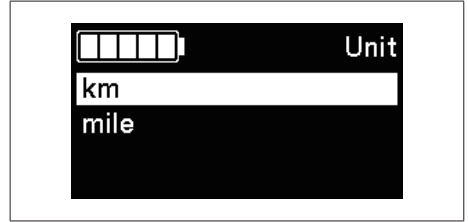
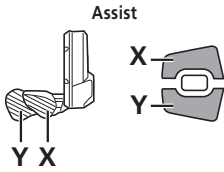

Configurable items	Details
[km]	Displayed in km
[mile]	Displayed in miles

2. Press Assist-A or the function button to confirm the setting.
 - After confirmation, the screen will automatically return to the menu list screen.

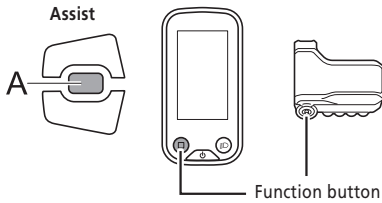

[Language] Language setting

Configure the language setting.

1. Press Assist-X or Assist-Y to select the required setting.

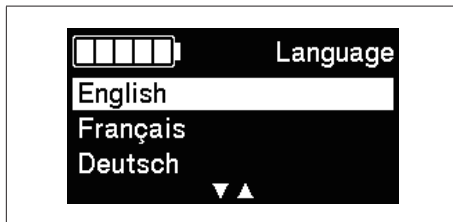
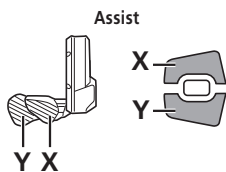

Language
English
French
German
Dutch
Italian
Spanish

2. Press Assist-A or the function button to confirm the setting.

- After confirmation, the screen will automatically return to the menu list screen.

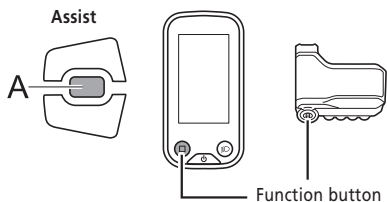

The font color can be changed.

1. Press Assist-X or Assist-Y to select the required setting.



Configurable items
[White]
[Black]

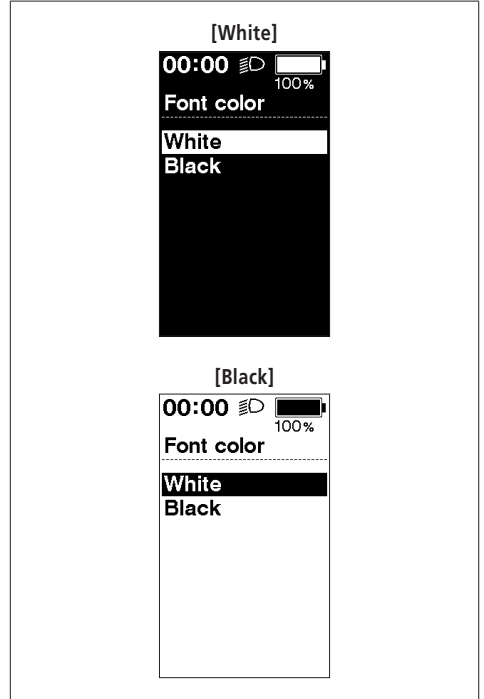

2. Press Assist-A or the function button to confirm the setting.
 - After confirmation, the screen will automatically return to the menu list screen.

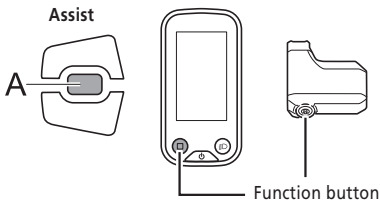

[Shift timing] Display timing setting (SC-E6100)

Set the timing at which gear shifting advice is displayed.

1. Press Assist-X or Assist-Y to adjust the values.
 - Pressing Assist-X to increase the value adjusts shift timing to make pedaling easier.
 - Pressing Assist-Y to decrease the value adjusts shift timing to make pedaling harder.

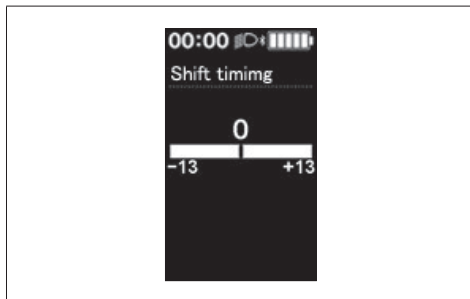
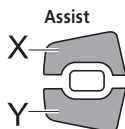

2. Press Assist-A or the function button to confirm the setting.

* The screen will automatically return to the setting menu screen.

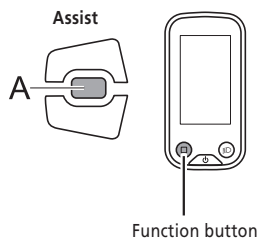

[Shifting advice] shifting advice setting (SC-E6100)

Sets whether to display the recommended gear shifting timing on the cycle computer during manual gear shifting.

1. Press Assist-X or Assist-Y to move the cursor to the item you want to configure.

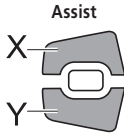

Configurable items	Details
[ON]	Enables the gear shifting advice function, which displays an icon to notify the user of the recommended timing for gear shifting during manual gear shifting.
[OFF]	Disable the shifting advice function

2. Press A or the function button to confirm the setting.

* The screen will automatically return to the setting menu screen.

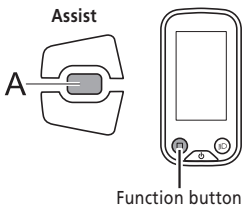

[Adjust] Gear shifting adjustment with the electronic gear shifting unit

You can adjust gear shifting only when using an electronic gear shifting unit.
If you need to adjust the derailleur, contact the place of purchase.

[RD protection reset] Reset RD protection

In order to protect the system when the bicycle falls and is subjected to a strong impact, the RD Protection function will activate and momentarily sever the connection between the motor and the link, impairing the proper function of the rear derailleur. Executing RD Protection Reset restores the connection between the motor and the link, as well as the function of the rear derailleur.

1. Press Assist-X or Assist-Y to select [OK].

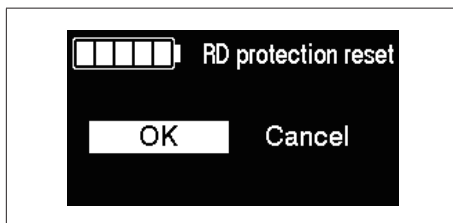
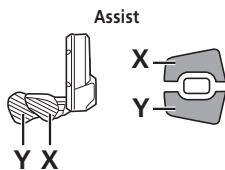

Configurable items	Details
[OK]	RD Protection Reset will operate
[Cancel]	To not execute RD Protection Reset, select [Cancel]

2. Press Assist-A or the function button to confirm [OK], recover the connection between the motor and the link by rotating the crank.

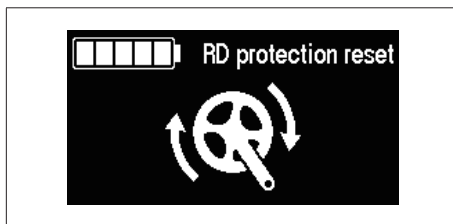
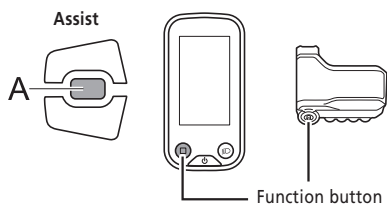

[Display speed] Adjusting the display speed (SC-E6100/SC-E7000)

Adjusts the displayed speed when there is a difference between the speed displayed on the cycle computer and other devices.

If the display on the cycle computer is adjusted, the actual speed may be higher than the displayed speed. Keep this in mind if riding in an area with a speed limit.

1. Press Assist-X or Assist-Y to adjust the number.
 - Press Assist-X to increase the number. The number displayed for the speed increases.
 - Press Assist-Y to decrease the number. The number displayed for the speed decreases.

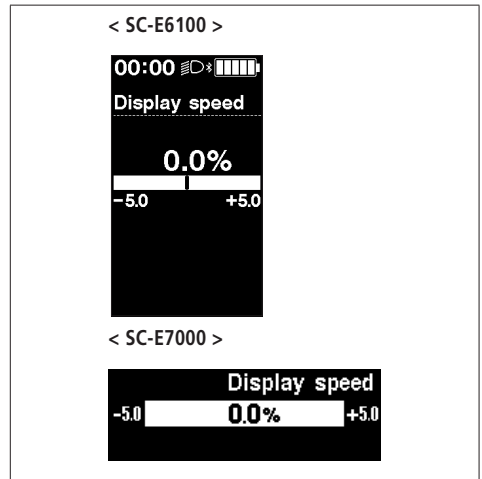
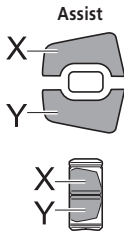

2. Press Assist-A or the function button to confirm the setting.
 - * The screen will automatically return to the setting menu screen.

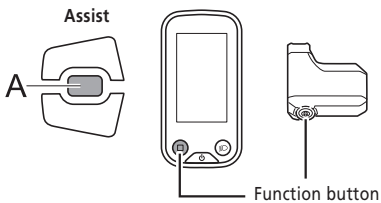

[Exit] Close setting menu screen

Closes the menu list screen and returns to the basic screen.

1. Press Assist-X or Assist-Y to select [Exit] on the menu list screen.
2. Press Assist-A to confirm. After confirmation, the screen will return to the basic screen.

Settings (EW-EN100)

The setting function cannot be used while riding the bicycle.

■ RD protection reset

In order to protect the system from falls etc., if the bicycle is subjected to a strong impact, the "RD Protection function" is enabled. The connection between the motor and the link will be momentarily severed so that the rear derailleur can no longer operate. Executing "RD Protection Reset" restores the connection between the motor and the link, as well as the function of the rear derailleur.

1. Hold the button down (for roughly eight seconds) until LED1 flashes red.
Once LED1 is flashing, release the button. When only LED1 is flashing red, the system is in the RD protection reset mode.

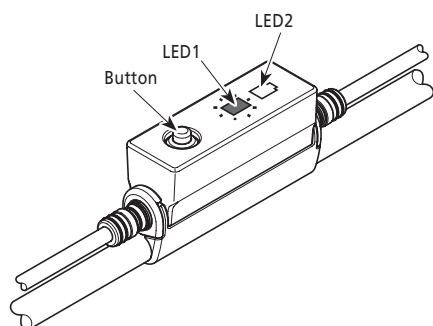

2. Rotate the crankarm.
Connection of motor and the link is restored.

■ Adjust

You can adjust gear shifting only when using an electronic gear shifting unit.
If you need to adjust the derailleur, contact the place of purchase.

Drive unit setting data backup function (SC-E8000/SC-E6010)

The data saved to the drive unit is usually backed up automatically. However, performing the following operations will cause a message to appear asking whether or not to update the backup data.

- Reinstalling the cycle computer on a bicycle with different settings.
- Changing the drive unit settings via E-TUBE PROJECT.

Connection and communication with devices

The system can be configured and firmware can be updated when the bicycle is connected to a device.

You need E-TUBE PROJECT to configure SHIMANO STEPS and update firmware.

Download E-TUBE PROJECT from the support website (<https://e-tubeproject.shimano.com>).

For information on how to install E-TUBE PROJECT, check the support website.

NOTICE

Connecting to devices is not possible while charging.



- SM-PCE1/SM-PCE02 is needed to connect SHIMANO STEPS to a PC. SMJC40/SM-JC41 will be needed in the following situations.
 - There are no free E-TUBE ports on the cycle computer (for example, if using electronic gear shifting)
 - If connecting the switch unit by itself to the PC
- Firmware is subject to change without notice.
If necessary, contact the place of purchase.

■ About wireless functions

Functions

ANT connection (SC-E8000/SC-E7000/SC-E6100/EW-EN100)

The wireless unit can send all information displayed on the basic screen of the cycle computer to an external device.



The latest functions can be checked by updating the software via E-TUBE PROJECT. For details, consult the place of purchase.

Bluetooth® LE connection (SC-E8000/SC-E7000/SC-E6100/EW-EN100)

The wireless unit can send all information displayed on the basic screen of the cycle computer to an external device.

E-TUBE PROJECT for smartphones/tablets may be used if a Bluetooth LE connection is established with a smartphone/tablet. SC-E7000, SC-E6100, and EW-EN100 are compatible with E-TUBE RIDE, which can be used to check traveling data on a smartphone connected over Bluetooth LE.

How to make connections

ANT connection (SC-E8000/SC-E7000/SC-E6100/EW-EN100)

When the main power is turned ON for SHIMANO STEPS, communication can be received at any time. Switch the external device to connection mode and then connect it. For SC-E8000, you can check [Bluetooth LE/ANT] to confirm whether the connection was successful.

Bluetooth® LE connection (SC-E8000)

Generally, Bluetooth LE transmission will begin automatically when the cycle computer is turned on, however, pairing can be started by [Bluetooth LE] menu when connectivity is poor.

Bluetooth® LE connection (SC-E7000/SC-E6100/EW-EN100)

Communication can only be received under the following conditions. Switch the external device to connection mode in advance.

- Within 15 seconds of the main power for SHIMANO STEPS turning ON.
- Within 15 seconds of operating any button other than the SHIMANO STEPS power switch.

2.4 GHz digital wireless system (SC-E8000)

2.4 GHz-frequency digital wireless technology, which is the same technology used for wireless LAN.

However, on very rare occasions, objects and places may generate strong electromagnetic, waves and interference, which may result in incorrect measurement.

- Television, PC, radios, motors/engines, or in car and trains.
- Railroad crossings and near railway tracks, around television transmitting stations and radar bases.
- Other wireless computers or digitally controlled light.

Troubleshooting

■ Error messages on the cycle computer

Warnings

If the situation is resolved, this indication will disappear.
If the situation does not improve, consult a distributor.

SC-E8000



SC-E7000



SC-E6100



List of warnings

Code	Display preconditions	Operational restrictions while warning is displayed	Remedy
W010	Temperature of the drive unit is higher than it is during times of normal operation.	Power assistance may be lower than usual.	Stop using the assist function until the temperature of the drive unit drops.
W011	The traveling speed cannot be detected.	The maximum speed up to which power assistance is provided may be lower than usual.	Contact your place of purchase or a local bicycle dealer for assistance, since there is a chance of the following: <ul style="list-style-type: none"> • The speed sensor is installed in the wrong position. • The magnet included with the disc brake rotor has come off.

Code	Display preconditions	Operational restrictions while warning is displayed	Remedy
W013	Initialization of torque sensor was not completed successfully.	Power assistance may be lower than usual.	With your foot off the pedal, press the battery power button and turn on the power again.
W020	If the temperature exceeds the guaranteed operating range, the battery output is turned off.	No system functions will start.	If it has exceeded the temperature in which discharge is possible, leave the battery in a cool place away from direct sunlight until the internal temperature of the battery decreases sufficiently. If it is below the temperature in which discharge is possible, leave the battery indoors, etc. until its internal temperature is at a suitable temperature.
W032	An electronic derailleur may have been installed in place of a mechanical derailleur.	Power assistance provided in [WALK] mode may be lower than usual. * The Walk assist mode function may not be able to be used in certain regions.	Reinstall the derailleur for which the system is configured to support.



Errors

If an error message is displayed on the entire screen, follow one of the procedures below to reset the display.

- Press the power button of the battery.
- Remove the battery from the holder.



If the situation does not improve even after turning the power back ON, consult with a distributor.



List of errors

Code	Display preconditions	Operational restriction when an error is being displayed	Remedy
E010	A system error was detected.	Power assistance is not provided during riding.	Press the power button of the battery to turn it on again.
E013	An anomaly was detected in the drive unit's firmware.	Power assistance is not provided during riding.	Contact the place of purchase or bicycle dealer. If the situation does not improve even after turning the power back ON, consult with a distributor.
E014	The speed sensor may have been installed in the wrong position.	Power assistance is not provided during riding.	Contact the place of purchase or bicycle dealer.
E020	A communication error between the battery and drive unit was detected.	Power assistance is not provided during riding.	Check that the cable between the drive unit and battery is properly connected.
E021	Battery connected to drive unit conforms with system standards but is not supported.	Power assistance is not provided during riding.	Press the power button of the battery to turn it on again.
E022	Battery connected to drive unit does not conform with system standards.	No system functions will start.	Press the power button of the battery to turn it on again.
E023	Electrical failure inside the battery	No system functions will start.	Use the battery power button to turn the power OFF, and then turn the power back ON.
E024	Communication error with the bicycle system	No system functions will start.	Make sure that the cable is not loose or improperly connected.

Code	Display preconditions	Operational restriction when an error is being displayed	Remedy
E025	This is displayed when a genuine drive unit is not connected. This is displayed if any of the cables are disconnected.	No system functions will start.	Connect a genuine battery and drive unit. Check the condition of the cables.
E033	The current firmware doesn't support system operation.	Power assistance is not provided during riding.	Connect to E-TUBE PROJECT and update firmware for all unit.
E043	Part of the cycle computer's firmware may be damaged.	Power assistance is not provided during riding.	Contact the place of purchase or bicycle dealer.

Error indications (EW-EN100)

When an error occurs, the two LEDs on EW-EN100 will quickly flash red at the same time.

If this occurs, follow one of the procedures below to reset the indication.

- Press the battery power switch to turn the power OFF.
- Remove the battery from the mount.

If the situation does not improve even after turning the power back ON, consult with a distributor.

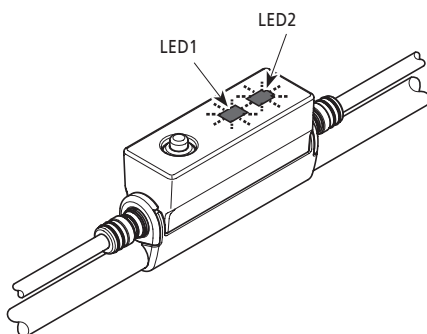

■ Troubleshooting

Assist function

Symptom	Cause / Possibility	Remedy
Assistance is not being provided.	Is the battery sufficiently charged?	Check the battery charge. If the battery is nearly spent, recharge it.
	Are you riding on long slopes in summer weather or riding for a long time carrying a heavy load? The battery may be overheating.	Turn off the power, wait for a while and then check once more.
	The drive unit, cycle computer or assist switch may be connected incorrectly or there may be a problem with one or more of them.	Contact the place of purchase.
	Is the speed too high?	Check the cycle computer display. Assistance is not provided at speeds set by the manufacturer or more.
	Are you pedaling?	The bicycle is not a motorbike, so you need to operate the pedals.
	Is the assist mode set to [OFF]?	Set assist mode to a mode other than [OFF]. If you still do not feel that assistance is being given, contact the place of purchase.
	Is the system power ON?	If you have performed the steps below and still do not feel the assistance, contact the place of purchase. Use the power switch on the cycle computer or the battery power button to turn the power back on.
Assist traveling distance is too short.	The traveling distance may become shorter depending on road conditions, the gear position and total light usage time.	Check the battery charge. If the battery is nearly spent, recharge it.
	The battery characteristics will drop during winter weather.	This is not a sign of a problem.
	The battery is a consumable part. Repeated recharging and long periods of use will cause the battery to deteriorate (lose its performance).	If the distance that can be traveled on a single charge is very short, replace the battery with a new one.
	Is the battery fully charged?	If the distance that can be traveled when the battery is fully charged has decreased, the battery may have degraded. Replace the battery with a new one.

Symptom	Cause / Possibility	Remedy
Pedaling is stiff.	Are the tires inflated to a sufficient pressure?	Use a pump to add air.
	Is the assist mode set to [OFF]?	Set the assist mode to [BOOST]. If you still do not feel that assistance is being given, contact the place of purchase.
	The battery may be running low.	After charging the battery well, check the level of assistance again. If you still do not feel that assistance is being given, contact the place of purchase.
	Did you turn on the power with your foot placed on the pedal?	Turn on the power again without putting pressure on the pedal. If you still do not feel that assistance is being given, contact the place of purchase.

Battery

Symptom	Cause / Possibility	Remedy
The battery quickly loses its charge.	The battery may be at the end of its service life.	Replace the battery with a new one.
The battery cannot be recharged.	Is the power plug of the charger securely inserted into the electrical outlet?	Disconnect and then reconnect the power plug of the charger, and then repeat the recharging operation. If the battery still cannot be recharged, contact the place of purchase.
	Is the charging plug of the charger securely inserted into the battery?	Disconnect and then reconnect the charging plug of the charger, and then repeat the recharging operation. If the battery still cannot be recharged, contact the place of purchase.
	Is the charging adapter securely connected to the charging plug, or to the battery charging port?	Securely connect the charging adapter to the charging plug or to the battery charging port, and charge again. If the battery still does not charge, contact the place of purchase.
	Is the connecting terminal for the battery charger, charging adapter, or battery dirty?	Wipe the connection terminals with a dry cloth to clean them, and then repeat the recharging operation. If the battery still cannot be recharged, contact the place of purchase.
The battery does not start recharging when the charger is connected.	The battery may be at the end of its service life.	Replace the battery with a new one.
The battery and charger are becoming hot.	The temperature of the battery or charger may have exceeded the operating temperature range.	Stop recharging, wait for a while and then recharge again. If the battery is too hot to touch, it may indicate a problem with the battery. Contact the place of purchase.
The charger is warm.	If the charger is being used continuously to charge batteries, it may become warm.	Wait a while before using the charger again.
The LED on the charger does not illuminate.	Is the charging plug of the charger securely inserted into the battery?	Check the connection for any foreign objects before reinserting the charging plug. If there is no change, contact the place of purchase.
	Is the battery fully charged?	If the battery is fully charged, the LED on the battery charger turns off, but this is not a malfunction. Disconnect and then reconnect the power plug of the charger, and then repeat the recharging operation. If the LED on the charger still does not illuminate, contact the place of purchase.
The battery cannot be removed.		Contact the place of purchase.

Symptom	Cause / Possibility	Remedy
The battery cannot be inserted.		Contact the place of purchase.
Fluid is coming out from the battery.		Contact the place of purchase.
An abnormal odor can be detected.		Stop using the battery immediately and contact the place of purchase.
Smoke is coming out from the battery.		Stop using the battery immediately and contact the place of purchase.

Lights

Symptom	Cause / Possibility	Remedy
The front light or the tail light does not illuminate even when the switch is pressed.	The E-TUBE PROJECT settings may be wrong.	Contact the place of purchase.

Cycle computer

Symptom	Cause / Possibility	Remedy
The cycle computer is not displayed when you push the battery power button.	The amount of battery charge may be insufficient.	Recharge the battery, and then turn the power on once more.
	Is the power turned on?	Hold down the power button to turn on the power.
	Is the battery charging?	The power cannot be turned on while the battery is mounted on the bicycle and being charged. Stop charging.
	SC-E6010/SC-E6100 Is the cycle computer correctly installed to the bracket?	Install the cycle computer correctly while referring to "Installing and removing the cycle computer".
	Is the electric wire connector correctly installed?	Check to see if the connector of the electric wire connecting the motor unit to drive unit is not disconnected. If you are not sure, contact the place of purchase.
	A component that the system cannot identify may be connected.	Contact the place of purchase.
SC-E6010/SC-E6100 The system does not start up when you press or press and hold the cycle computer power button for 2 seconds.	Did you use the cycle computer in, or expose it to, low temperatures for an extended period?	The cycle computer may become unable to turn on if used in, or exposed to, low temperatures for an extended period. Turn it on by pressing the power button on the battery. If it still does not turn on, contact the place of purchase.
	Is the cycle computer correctly installed to the bracket?	Install the cycle computer correctly while referring to "Installing and removing the cycle computer".
The gear position is not displayed.	The gear position is only displayed when using the electronic gear shifting unit.	Check if the electric wire connector is disconnected. If you are not sure, contact the place of purchase.

Symptom	Cause / Possibility	Remedy
Can the beep be turned off.		Change the setting. Refer to "[Beep] Beep setting".
SC-E6010/SC-E6100 Can the backlight be turned off.		Change the setting. Refer to "[Backlight] backlight setting (SC-E6010/SC-E6100)".
The setting menu cannot be launched while riding the bicycle.	The product is designed so that if it detects that the bicycle is being ridden, the setting menu cannot be launched. This is not a sign of an abnormality.	Stop the bicycle and then make the settings.

Other

Symptom	Cause / Possibility	Remedy
When pressing the switch, two beeps sound, and the switch cannot be operated.	Operation of the switch being pressed has been disabled.	It is not a sign of a malfunction.
Three beeps sound.	An error or warning is occurring.	This occurs when a warning or error is displayed on the cycle computer. Refer to the section "Error messages on the cycle computer" and follow the instructions provided for the appropriate code.
When using an electronic gear shifting, I feel that the level of assistance weakens when the gears shift.	This occurs because the level of assistance is being adjusted to the optimum level by computer.	It is not a sign of a malfunction.
Sound occurs after gear shifting.		Contact the place of purchase.
A noise can be heard from the rear wheel during normal riding.	Gear shifting adjustment may not have been carried out correctly.	For mechanical gear shifting Adjust the cable tension. For details, refer to the owner's manual for the derailleur. For electronic gear shifting Contact the place of purchase.
When you stop the bicycle, the gear does not shift to the position preset in the start mode.	You may have been pressing the pedals too strongly.	If you press the pedals lightly, the gear shifts more easily.

*** Key number**

The number that is on the key is required should you need to purchase spare keys.
Enter the key number in the box below and keep in a safe place.

Key number

SHIMANO

SHIMANO NORTH AMERICA BICYCLE, INC.

One Holland, Irvine, California 92618, U.S.A. Phone: +1-949-951-5003

SHIMANO EUROPE B.V.

High Tech Campus 92, 5656 AG Eindhoven, The Netherlands Phone: +31-402-612222

MADISON (A DIVISION OF H.YOUNG (OPERATIONS) LTD)

Roebuck Way, Knowlhill, Milton Keynes, Buckinghamshire, MK5 8HL, United Kingdom

SHIMANO INC.

3-77 Oimatsu-cho, Sakai-ku, Sakai City, Osaka 590-8577, Japan

Please note: specifications are subject to change for improvement without notice. (English)

© Dec. 2020 by SHIMANO INC. ITP